

# **TN-5305 Series Hardware Installation Guide**

---

**M12 unmanaged Ethernet switches**

**Moxa ToughNet Switch**

**Second Edition, April 2014**

**MOXA<sup>®</sup>**

© 2014 Moxa Inc. All rights reserved.

**P/N: 1802053050011**

## Overview

The Moxa ToughNet TN-5305 series of 5-port Ethernet switches provides a hardened and cost-effective solution for your Ethernet connections. The TN-5305 switches are IP67-rated to provide protection against shock and foreign particles. IP67-rated products have the following characteristics: (1) dust proof, (2) protection against the effects of temporary immersion in water.

The TN-5305 switches have a wide operating temperature range of -40 to 75°C, and are designed to withstand a high degree of vibration and shock. The rugged hardware design makes the TN-5305 switches perfect for ensuring that your Ethernet equipment can withstand the rigors associated with critical industrial applications. The switches are rated for use in hazardous locations and comply with CE/FCC, UL and EN50155 (railway applications) standards.

## Package Checklist

Your TN-5305 is shipped with the following items. If any of these items is missing or damaged, please contact your customer service representative for assistance.

- Moxa ToughNet Switch.
- Hardware Installation Guide.
- Product Warranty Statement.
- 3 protective caps for unused ports and 8 port labels.
- Panel Mounting Kit.

## Features

### ***High Performance Network Switching Technology***

- 5 10/100BaseT(X) ports (4-pin shielded M12 socket with D coding).
- Broadcast storm protection.
- IEEE802.3/802.3u/802.3x.
- Store and Forward switching process type.
- 10/100M, Full/Half-Duplex, MDI/MDIX auto-sensing.

### ***Industrial Grade Reliability***

- Active circuit protection.
- Robust connection.
- Dust and immersion proof.

### ***Rugged Design***

- Casing design meets IP67 protection standards.
- M12 connectors for robust connections.
- Operating temperature range of -25 to 60°C, or extended operating temperature range of -40 to 75°C.

# TN-5305 Panel Layouts

## Front Panel View

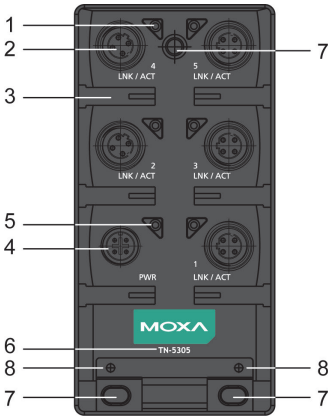

1. M12 port's 10/100 Mbps LED.
2. 10/100BaseT(X) port (4-pin female shielded M12 socket with D coding).
3. Port Label.
4. Power input (5-pin male shielded M12 socket with A coding).
5. Power input (PWR) LED.
6. Model name.
7. Holes for attaching the TN-5305 to a wall with screws (there are 3 holes: bottom left, bottom right, and top middle).
8. Grounding screws.

## Mounting Dimensions (unit = mm)

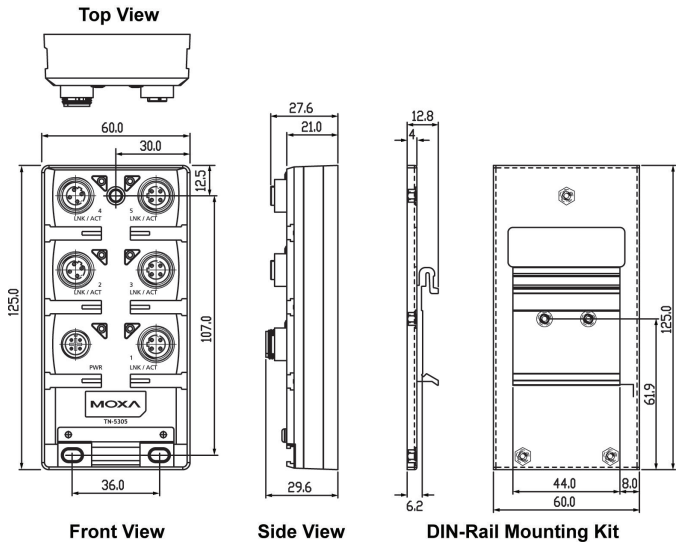

## Panel/Wall Mounting

To mount the TN-5305 on the wall use the 3 screws included in the panel mounting kit.

**STEP 1:** Make 3 screw holes on the wall based on the positions of the 3 screw holes on the switch shown in the mounting dimensions diagram.

**STEP 2:** Insert one screw in the top-middle screw hole on the switch and screw it into the wall.

**STEP 3:** Screw in the remaining 2 screws through the bottom-left and bottom-right holes on the switch.

## DIN-Rail Mounting (optional)

Use the optional DIN-Rail mounting kit (DK-M12-305, must be purchased separately) to mount the TN-5305 on a 35-mm DIN rail.

### STEP 1:

Fix the DIN-Rail attachment plate to the rear panel of the switch as shown in the above figure.

### STEP 2:

Position the top hook of the DIN-Rail attachment plate to the top edge of the rail.

### STEP 3:

Rotate the switch downwards until the bottom of the attachment plate latches onto the bottom edge of the rail.

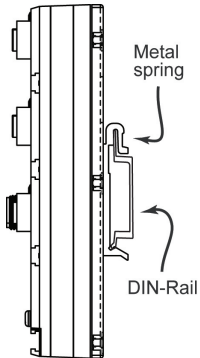
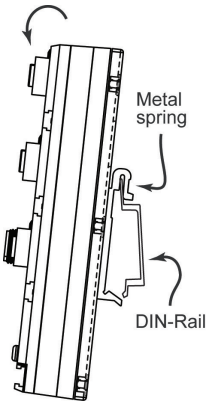

To remove the switch from the DIN-Rail, simply reverse Steps 2 and 3 above.

## Wiring Requirements



### WARNING

Turn the power off before disconnecting modules or wires. The correct power supply voltage is listed on the product label. Check the voltage of your power source to make sure that you are using the correct voltage. Do NOT use a voltage greater than what is specified on the product label.

These devices must be supplied by a SELV source as defined in the Low Voltage Directive 2006/95/EC and 2004/108/EC.



### ATTENTION

#### Safety First!

Be sure to disconnect the power cord before installing and/or wiring your Moxa switch.

This device has UL508 approval. Use copper conductors only, 60/75°C, Tighten To 4.5 pound-inches. For use in Pollution Degree 2 Environment.



### ATTENTION

#### Safety First!

Calculate the maximum possible current in each power wire and common wire. Observe all electrical codes dictating the maximum current allowable for each wire size. If the current goes above the maximum ratings, the wiring could overheat, causing serious damage to your equipment.

You should also heed the following guidelines:

- Use separate paths to route wiring for power and devices. If power wiring and device wiring paths must cross, make sure the wires are perpendicular at the intersection point.  
**NOTE: Do not run signal or communications wiring and power wiring in the same wire conduit. To avoid interference, wires with different signal characteristics should be routed separately.**
- You can use the type of signal transmitted through a wire to determine which wires should be kept separate. The rule of thumb is that wiring that shares similar electrical characteristics can be bundled together.
- Keep input wiring and output wiring separated.
- It is strongly advised that you label wiring to all devices in the system when necessary.

## Grounding the TN-5305

Grounding and wire routing help limit the effects of noise due to electromagnetic interference (EMI). Run the ground connection from the ground screw to the grounding surface prior to connecting devices.

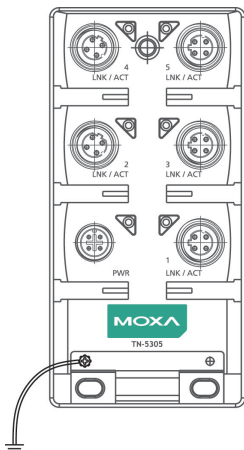

### ATTENTION

This product is intended to be mounted to a well-grounded mounting surface such as a metal panel.

## 10/100BaseT(X) Ethernet Port Connection

All TN-5305 models have 5 10/100BaseT(X) Ethernet ports (4-pin shielded M12 socket with D coding). The 10/100TX ports located on the TN-5305's front panel are used to connect to Ethernet-enabled devices. Most users configure these ports for Auto MDI/MDI-X mode, in which case the port's pinouts are adjusted automatically depending on the type of Ethernet cable used (straight-through or cross-over), and the type of device (NIC-type or HUB/Switch-type) connected to the port.

In what follows, we give pinouts for both MDI (NIC-type) ports and MDI-X (HUB/Switch-type) ports. We also give cable wiring diagrams for straight-through and cross-over Ethernet cables.

### Pinouts for sockets on TN-5305

#### TP Port

PIN	TX
1	TD+
2	RD+
3	TD-
4	RD-



#### Power input

Pin 1	Input V+
Pin 2	Not assigned
Pin 3	Input V-
Pin 4	Not assigned
Pin 5	Function ground

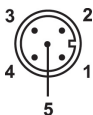

## Pinouts for RJ45 (8-pin)

### RJ45 (8-Pin)

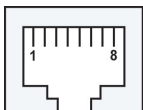

### MDI Port Pinouts

Pin	Signal
1	Tx +
2	Tx -
3	Rx +
6	Rx -

### MDI-X Port Pinouts

Pin	Signal
1	Rx +
2	Rx -
3	Tx +
6	Tx -

## M12 (4-pin, M) to M12 (4-pin, M) Cross-Over Cable Wiring



### Cross-Over Cable Wiring

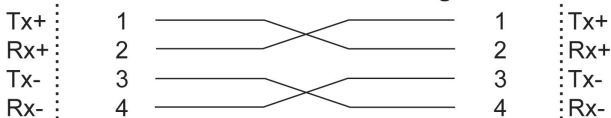

## M12 (4-pin, M) to M12 (4-pin, M) Straight-Trough Cable Wiring



### Straight-through Cable Wiring

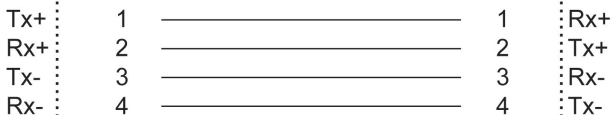

## M12 (4-pin, M) to RJ45 (8-pin) Cross-Over Cable Wiring



### Cross-Over Cable Wiring

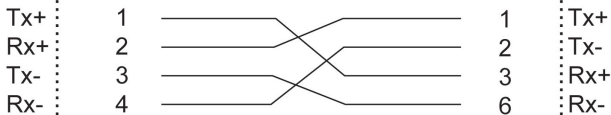

## M12 (4-pin, M) to RJ45 (8-pin) Straight-Trough Cable Wiring



### Straight-through Cable Wiring

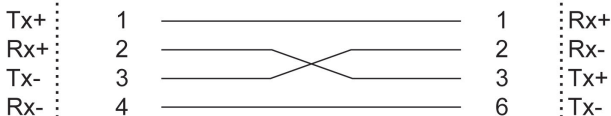

## Auto MDI/MDI-X Connection

The Auto MDI/MDI-X function allows users to connect TN-5305's 10/100BaseTX ports to any kind of Ethernet device, without needing to pay attention to the type of Ethernet cable being used for the connection. This means that you can use either a straight-through cable or cross-over cable to connect the TN-5305 to Ethernet devices.

## LED Indicators

Several LED indicators are located on the TN-5305's front panel. The function of each LED is described in the table below.

LED	Color	State	Description
<b>PWR</b>	AMBER	On	Power is being supplied to the power input.
		Off	Power is not being supplied to the power input.
<b>LNK/ACT (10M)</b>	AMBER	On	TP port's 10 Mbps link is active.
		Blinking	Data is being transmitted at 10 Mbps
		Off	TP port's 10 Mbps link is inactive.
<b>LNK/ACT (100M)</b>	GREEN	On	TP port's 100 Mbps link is active
		Blinking	Data is being transmitted at 100 Mbps.
		Off	TP port's 100 Mbps link is inactive.

## Auto-Negotiation and Speed Sensing

All of the TN-5305's Ethernet ports independently support auto-negotiation for speeds in the 10BaseT and 100BaseTX modes, with operation according to the IEEE 802.3u standard. This means that some nodes could be operating at 10 Mbps, while at the same time, other nodes are operating at 100 Mbps.

Auto-negotiation takes place when an M12 cable connection is made, and then each time a LINK is enabled. The TN-5305 advertises its capability for using either 10 Mbps or 100 Mbps transmission speeds, with the device at the other end of the cable expected to advertise in the same way. Depending on what type of device is connected, this will result in agreement to operate at a speed of either 10 Mbps or 100 Mbps.

If an TN-5305's Ethernet port is connected to a non-negotiating device, it will default to 10 Mbps speed and half-duplex mode, as required by the IEEE 802.3u standard.



## Specifications

### Technology

Standards	IEEE 802.3, 802.3u, 802.3x
Processing Type	Store and Forward, with IEEE802.3x full duplex, back pressure flow control

### Interface

M12 Ports	10/100BaseTX auto negotiation speed, F/H duplex mode, and auto MDI/MDI-X connection
LED Indicators	Power, LNK/ACT

### Power

Input Voltage	24 VDC (12 to 45 VDC) or 18 to 30 VAC (47 to 63 Hz)
Input Current	0.12A @ 24 VDC 0.28A @ 24 VAC
Connection	M12 A-coding 5-pin male connector, single power input

### Protection

Overload current protection / Limited current	1.1A
Reverse polarity protection	present

### Mechanical

Casing	IP67 protection, plastic case
Dimensions (W x H x D)	60 x 125 x 29.6 mm (2.4 x 4.9 x 1.2 in)
Weight	250g
Installation	Panel mounting, DIN-Rail mounting (with optional kit)

### Environment

Operating Temperature	-25 to 60°C (-13 to 140°F) for standard model, -40 to 75°C (-40 to 167°F) for -T models
Storage Temperature	-40 to 85°C (-40 to 185°F)
Operating relative humidity	5 to 95% (non-condensing)

### Regulatory Approvals

Safety	UL 508
Rail Traffic	EN 50155
Maritime	EMI: FCC Part 15, CISPR (EN55022) class A EMS: EN61000-4-2 (ESD), level 3 EN61000-4-3 (RS), level 3 EN61000-4-4 (EFT), level 3 EN61000-4-5 (Surge), level 3 EN61000-4-6 (CS), level 2 Shock: IEC60068-2-27 Free Fall: IEC60068-2-32 Vibration: IEC60068-2-6

**Note: Please check Moxa's website for the most up-to-date certification status.**

### MTBF (mean time between failures)

Time	370,224 hrs
Database	Telcordia (Bellcore), GB 25°C

### WARRANTY

5 years

**Technical Support Contact Information**  
**[www.moxa.com/support](http://www.moxa.com/support)**

Moxa Americas:

Toll-free: 1-888-669-2872

Tel: 1-714-528-6777

Fax: 1-714-528-6778

Moxa China (Shanghai office):

Toll-free: 800-820-5036

Tel: +86-21-5258-9955

Fax: +86-21-5258-5505

Moxa Europe:

Tel: +49-89-3 70 03 99-0

Fax: +49-89-3 70 03 99-99

Moxa Asia-Pacific:

Tel: +886-2-8919-1230

Fax: +886-2-8919-1231